

OLGA · CONFIGURATIONS

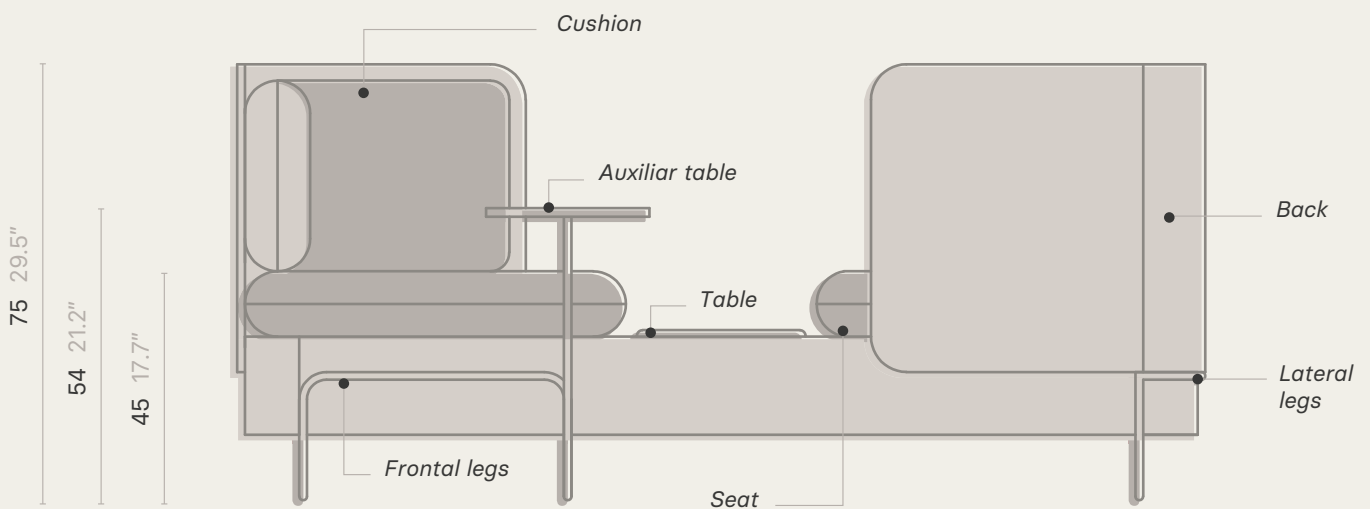

ABOUT OLGA

Olga is a collection of elegant, fully configurable, side seats with a contemporary design. Inspired by sensuality, the curve is Olga's main feature, being the common element in every one of its components.

As in its predecessors, Olga's encounter with materials is taken care of from the moment of its conception. Wood and metal create a perfect tandem, integrating in its structure and giving prominence to the textile and to its seams without pleats, details that accentuate the elegance of this collection.

SOBRE OLGA

Olga es una colección de elegantes asientos auxiliares completamente configurables de diseño contemporáneo. Inspirada en la sensualidad, la curva es elemento protagonista de Olga, siendo la característica común en cada uno de sus componentes.

Como en todas las piezas Momocca, el encuentro de materiales de Olga se cuida desde su concepción. Madera y metal forman un tándem perfecto, integrándose conjuntamente en su estructura y cediendo el protagonismo al textil y a sus costuras sin pliegues, detalles que acentúan la elegancia desprendida por esta colección.

DEPTH 45 cm

PROFUNDIDAD 45 cm

cm inches

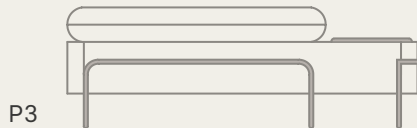
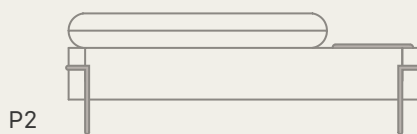
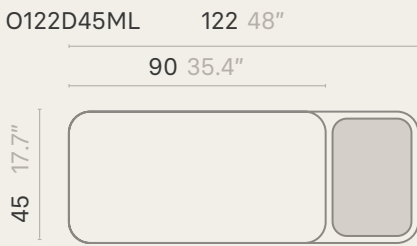
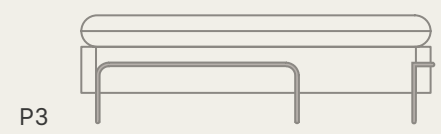
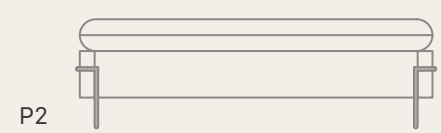
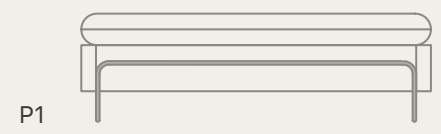
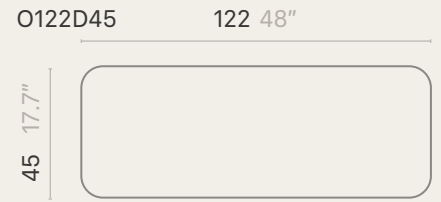
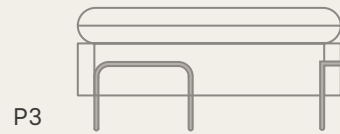
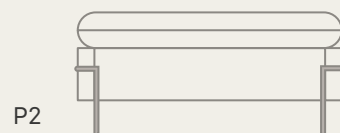
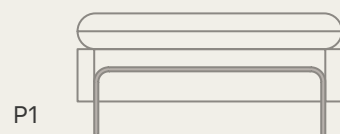
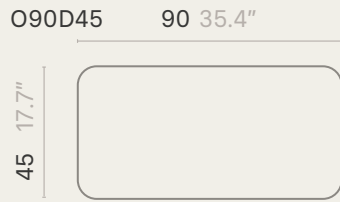
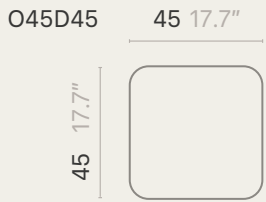

DEPTH 70 cm

PROFUNDIDAD 70 cm

cm inches

O70D70 70 27.5"

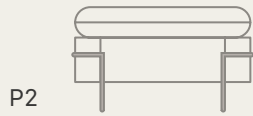
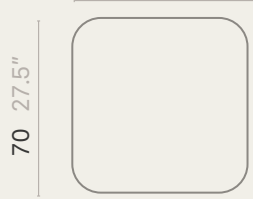

O105D70ML 105 41.3"

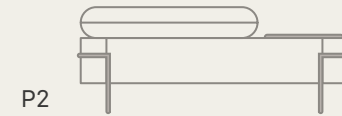
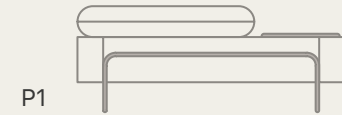
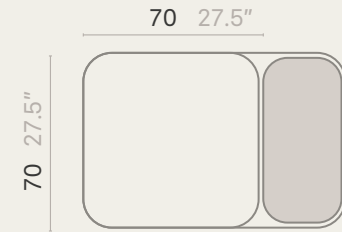

O140D70 140 55.1"

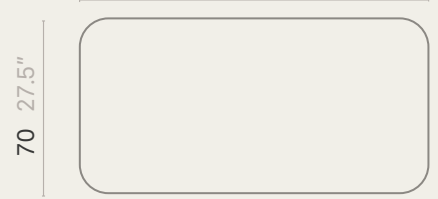

DEPTH 70 cm

PROFUNDIDAD 70 cm

cm inches

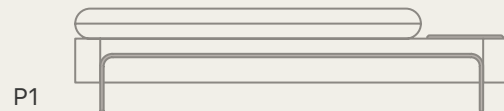
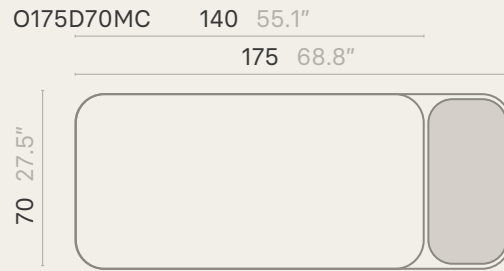
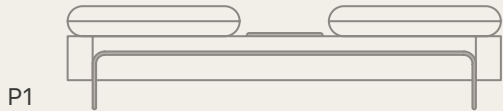
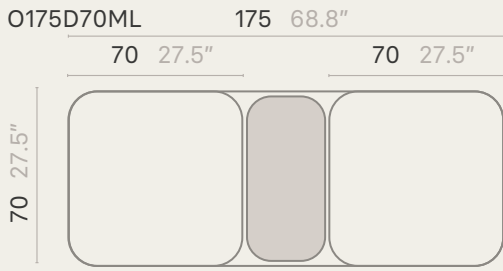

BACKS & CUSHIONS

RESPALDOS Y COJINES

cm inches

